

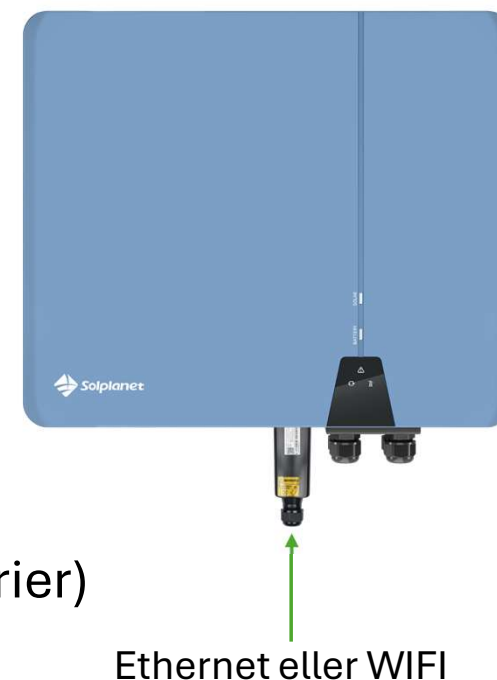

Parallel forbindelse af T2/T3 hybrid

Krav til installationen

- Samme effekt størrelse – T2 og T3 kan blandes.
 - Eksempler:
 - 8 kW T2 og 8 kW T3
 - 5 kW T2 og 5 kW T2
- Maksimum af 4 invertere i parallel
- Firmware på invertere
 - C06 eller nyere (V610-05001-12.000)
- Samme batteri og brand på hver inverter (hvis flere batterier)
- En dongle monteret på master inverter
- Et smart meter monteret på master inverter



1. Fysiske forbindelser

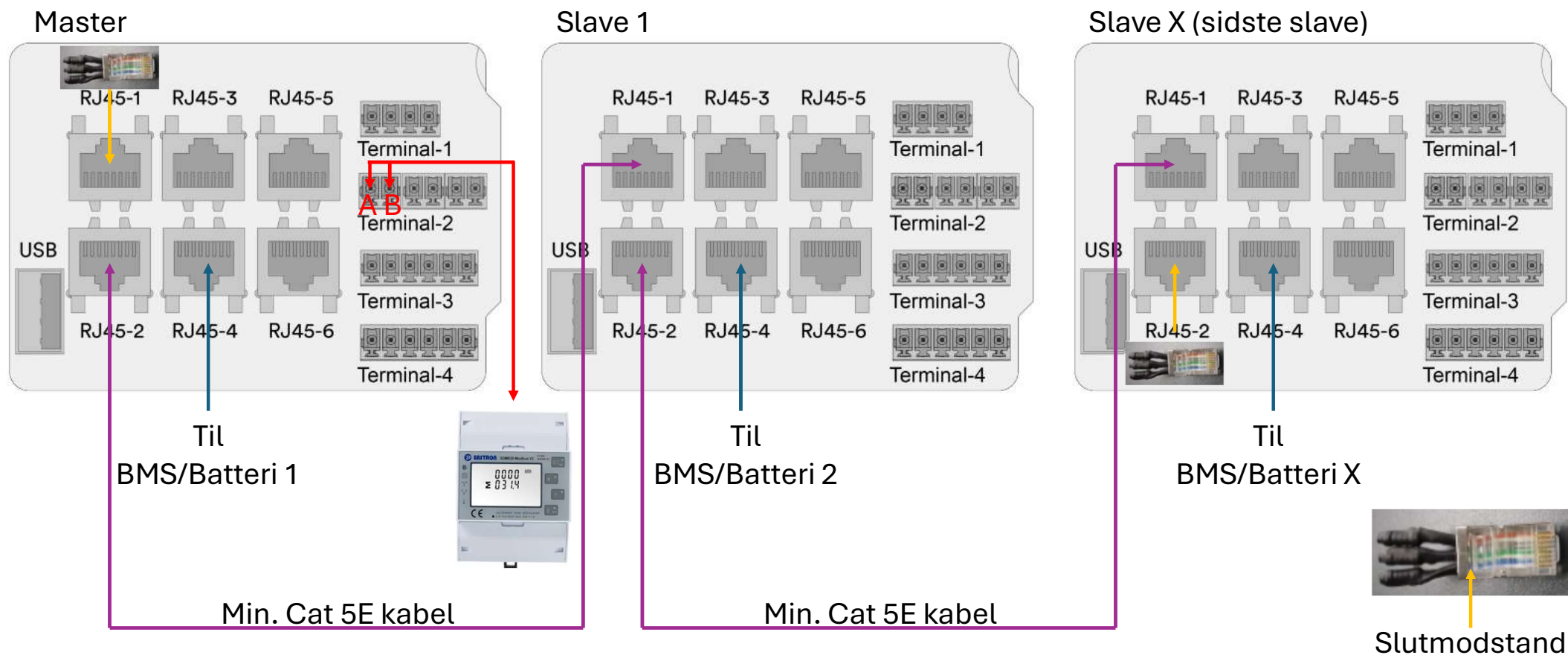

2. Kontrol af firmware

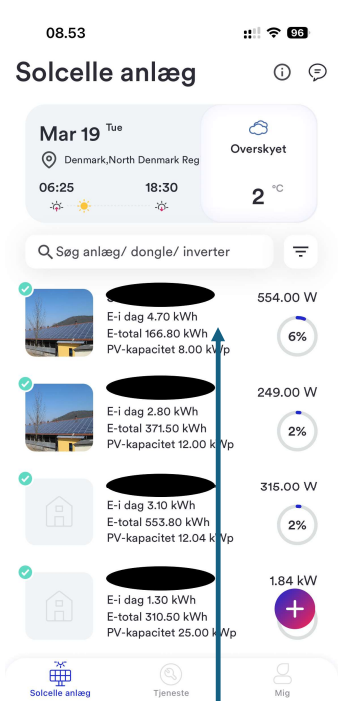

Tryk på anlægget

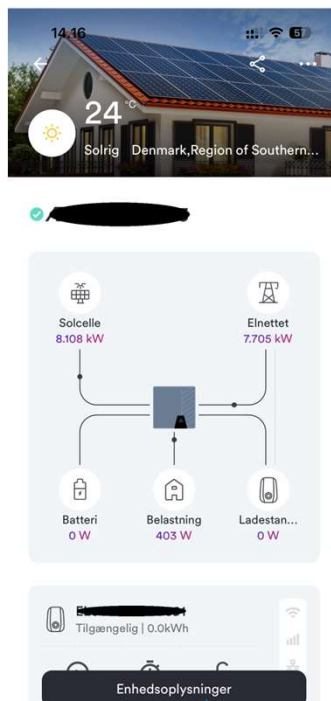

Enhedsoplysninger

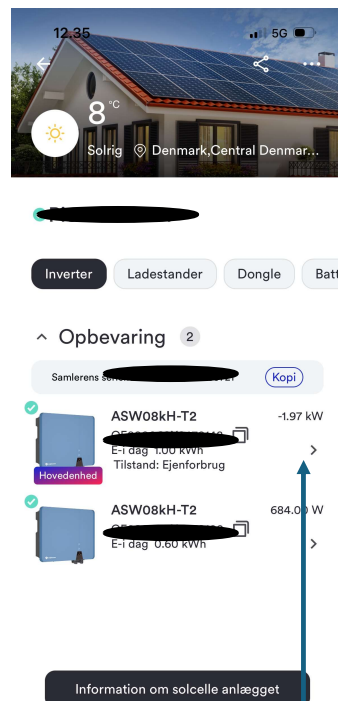

Klik på inverteren

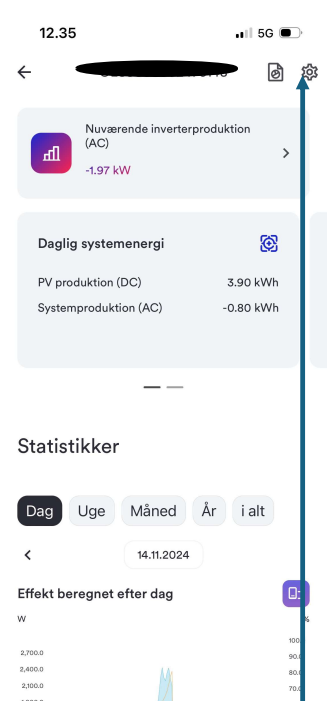

Klik på tandhjulet



Firmware opgradering

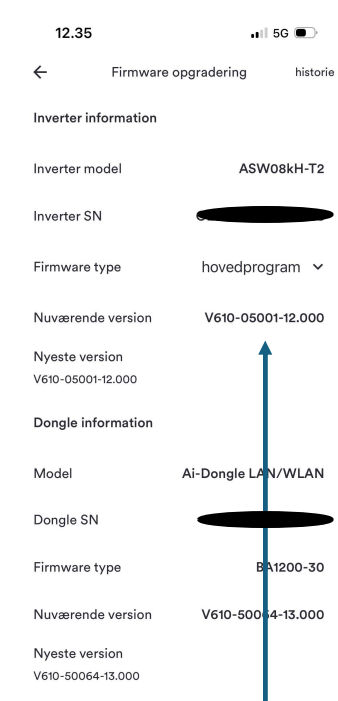

Kontroller versioner

Firmware versioner skal være:

Master:V610-05001-12.000
HMI:V610-50106-04.000

Safety:V610-11022-10
Dongle:V610-50064-13.000

Hvis inverterne ikke er opdateret kontakt os for opdatering.
Kontakt os på: +45 702 708 88

3. Scan inverter

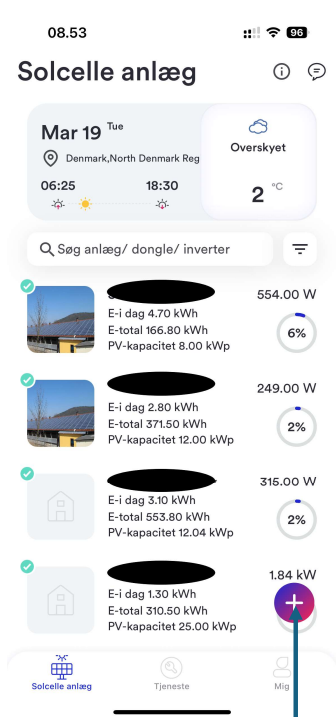

Tryk på lilla plus

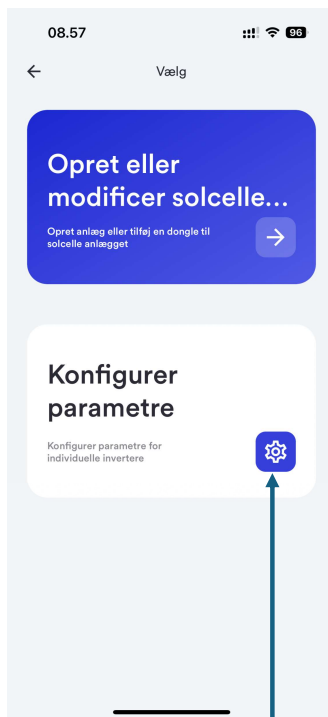

Konfigurer parameter

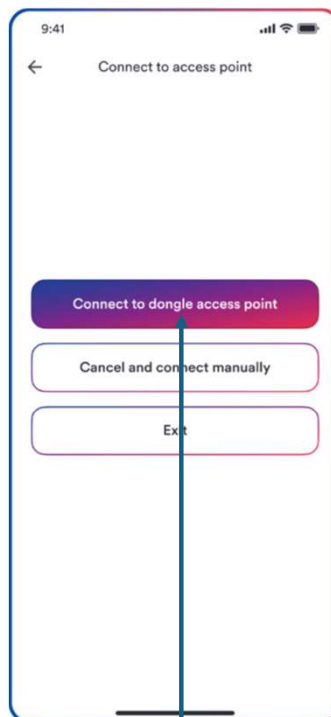

Forbind til dongle

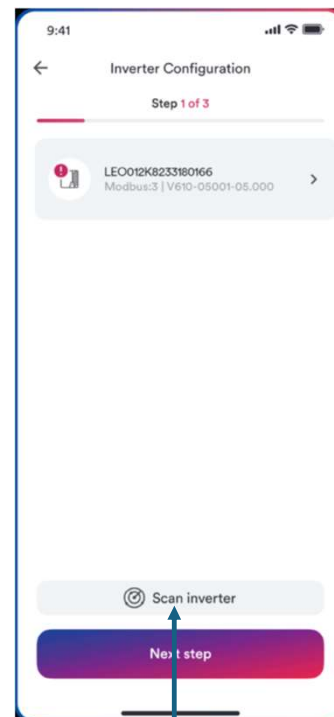

Scan inverter

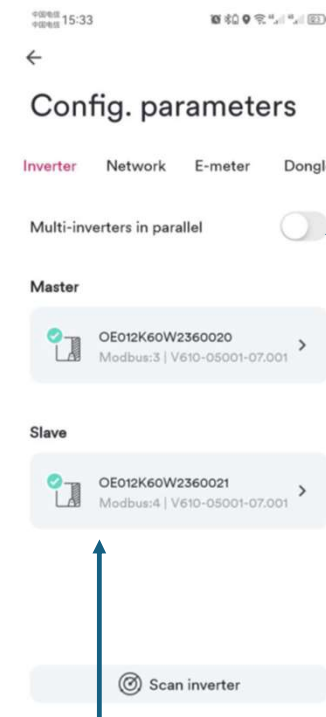

Når master og slave kommer frem er den færdig

OBS: Denne funktion skal IKKE aktiveres



4. Sidste steps

Alle indstillinger kan nu laves på ”Master” inverteren og bliver automatisk lagt på alle slave inverterne.

Husk:

- Grid code
- Indstilling af batteri model/antal
- Indstilling af arbejdstilstand på batteriet